

# Pin Header

Board Spacer Single / Dual Row  
Straight S.M.T Type

Pitch:2.54mm

**Series**  
460 25

**Odia** 奥比亚

Tel: (+86)0755-28248661/2/3  
Fax: (+86)0755-27857873

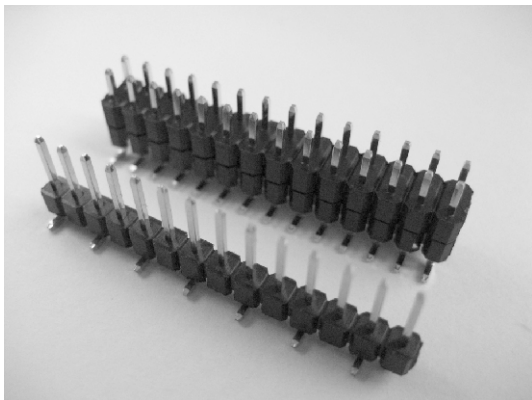

### SPECIFICATIONS (技术参数):

Current Rating (额定电流): 3.0 AMP  
Contact Resistance (接触电阻): 30mΩ Max  
Insulation Resistance (绝缘电阻): 1000MΩ Min  
Withstand Voltage (耐压值): 600VAC/minute  
Operation Temperature (工作温度): -40°C to +105°C

### MATERIALS(材质):

Contact Material (接触件材质): Copper Alloy  
Contact Plating (接触件电镀): Gold or Tin over 50 μ "Ni  
Insulator Material (绝缘体材质): Polyester(UL94V-0)  
Standard: PBT

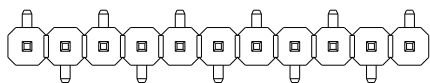

Single row - M1 Type

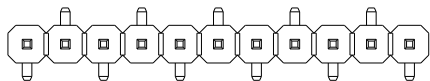

Single row - M2 Type

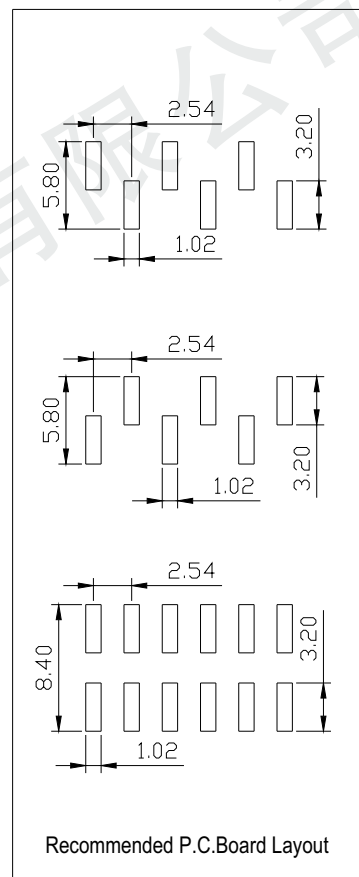
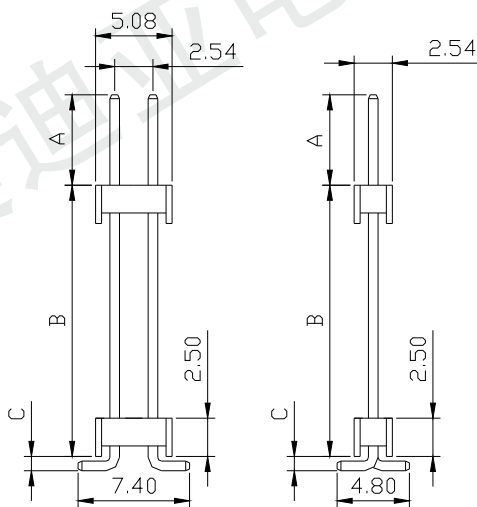
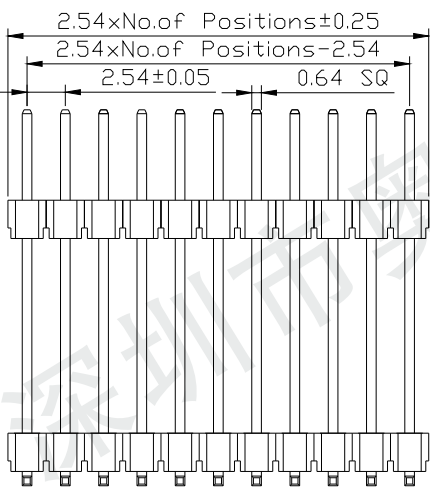
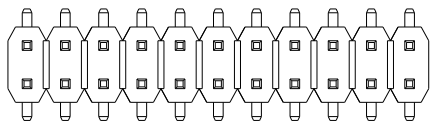

## Ordering Code

① ② ③ ④ ⑤ ⑥ ⑦ ⑧ ⑨ ⑩  
46025 1 2 30 M 1 4 2 XXX

① Series No.:  
460= Pin Header

② Pitch: 25 = 2.54mm

③ Insulator Height:  
1 = 2.50mm  
2 = 2.34mm  
3 = 2.00mm  
4 = 1.70mm  
5 = 1.50mm

④ Number of row:  
1=Sing row  
2=Double row

⑤ Number of Contacts:  
Single row=01(1x1)to 40(1x40)  
Double row=04(2x2)to 80(2x40)

⑥ Tail & Mounting Style:  
M=Straight SMT type

⑦ Contact Plated  
0=Tin 1=Gold Flash  
2=Gold 3u" 3=Gold 5u"  
4=Gold 10u" 5=Gold 15u"  
6= Gold 30u" A=Gold 1.5u"  
B=Gold 2u"

⑧ Material Type  
0=PPS 3=Nylon-9T  
1=PBT 4=Nylon-6T  
2=LCP 5=PA46

⑨ Tiers of Body  
1 = Single tier  
2 = Double tier  
3 = Triple tier

⑩ Pin Length  
XXX=A+B+C-0.64+(W/2)  
XXX=A+B+C-0.64+(W-2.54)/2